



PRODUCT NAME:LED Stainless Vanity
ITEM NUMBER:55582WTSN 55584WTSN 55586WTSN

Please consult your electrician for hanging fixture and wiring.



WARNING:Wires need to be connected to driver found in canopy and should not be connected directly to power source or a short may occur

55582WTSN : 22W LED 3000K NO DIMMABLE
55584WTSN : 28W LED 3000K NO DIMMABLE
55586WTSN : 35W LED 3000K NO DIMMABLE

PRODUCT NAME: LED Stainless Vanity
 ITEM NUMBER: 55582WTSN 55584WTSN 55586WTSN

CAUTION: Turn off the main power at the circuit breaker before installing and servicing the fixture to prevent possible injury from electric shock.

All electrical connections must be in accordance with local and National Electrical Code (N.E.C.) standards. If you are unfamiliar with proper electrical wiring connections, obtain the services of a qualified electrician.

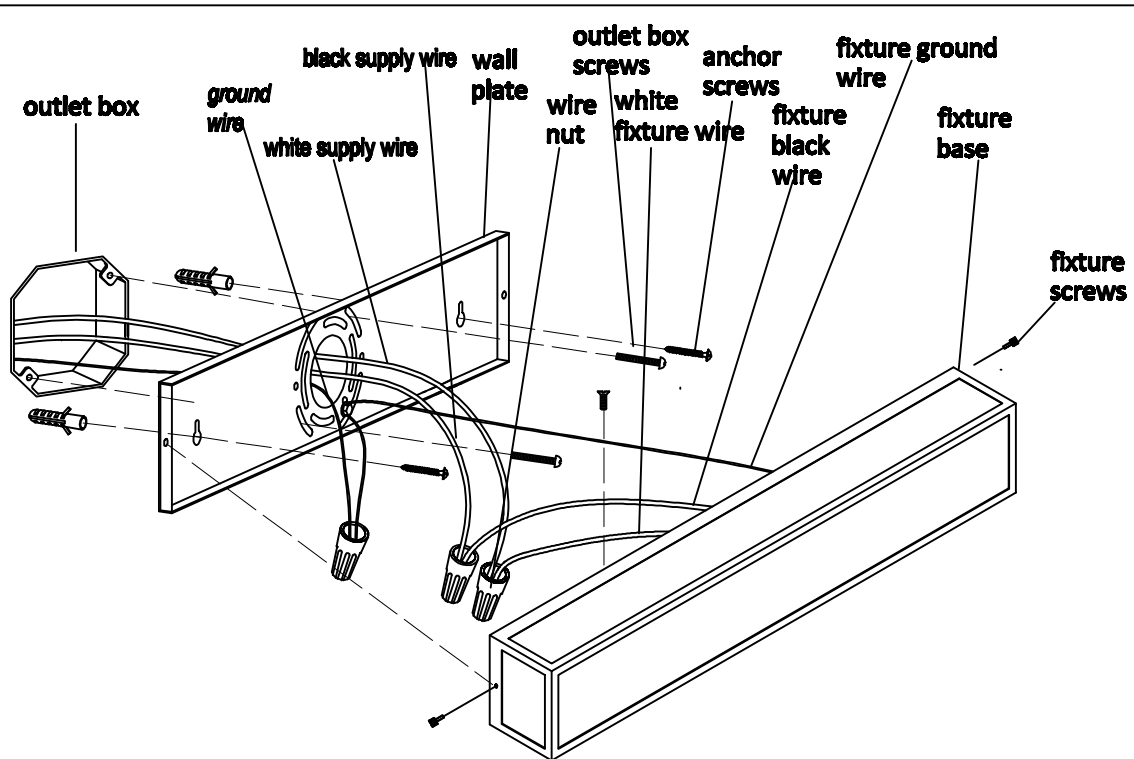

- 1: Place the mounting wall plate over the outlet box, align the mounting slots of the wall plate with holes of the outlet box as shown. Use a level to ensure the wall plate is straight.
- 2: Mark the location of the keyhole slots of the wall plate on the wall. Drill a 1/4" holes at the narrow end of each keyhole slot marking on the wall. Carefully hammer a wall anchor into each drilled hole.
- 3: Replace the mounting wall plate over outlet box, align the narrow end of each keyhole slot with its respective wall anchor. Feed the anchor screws through keyhole slots and thread them into the wall anchors until wall plate is flush against the wall. Additionally, fasten the wall plate to thread holes in outlet box using two outlet box screws, as shown.
- 5: Pull the supply wires and house ground wire out from the outlet box before attaching wall plate to outlet box. Make electrical connections, connect the black fixture black wire to the black supply wire and the white fixture wire to the white supply wire using wire nut. Connect the fixture ground wire to the supply ground wire together using wire nut. Wrap all wire connections with electrical tape to ensure secure connection.
- 6: Place the fixture base over the mounting wall plate and secure it to the wall plate by using four fixture screws.