

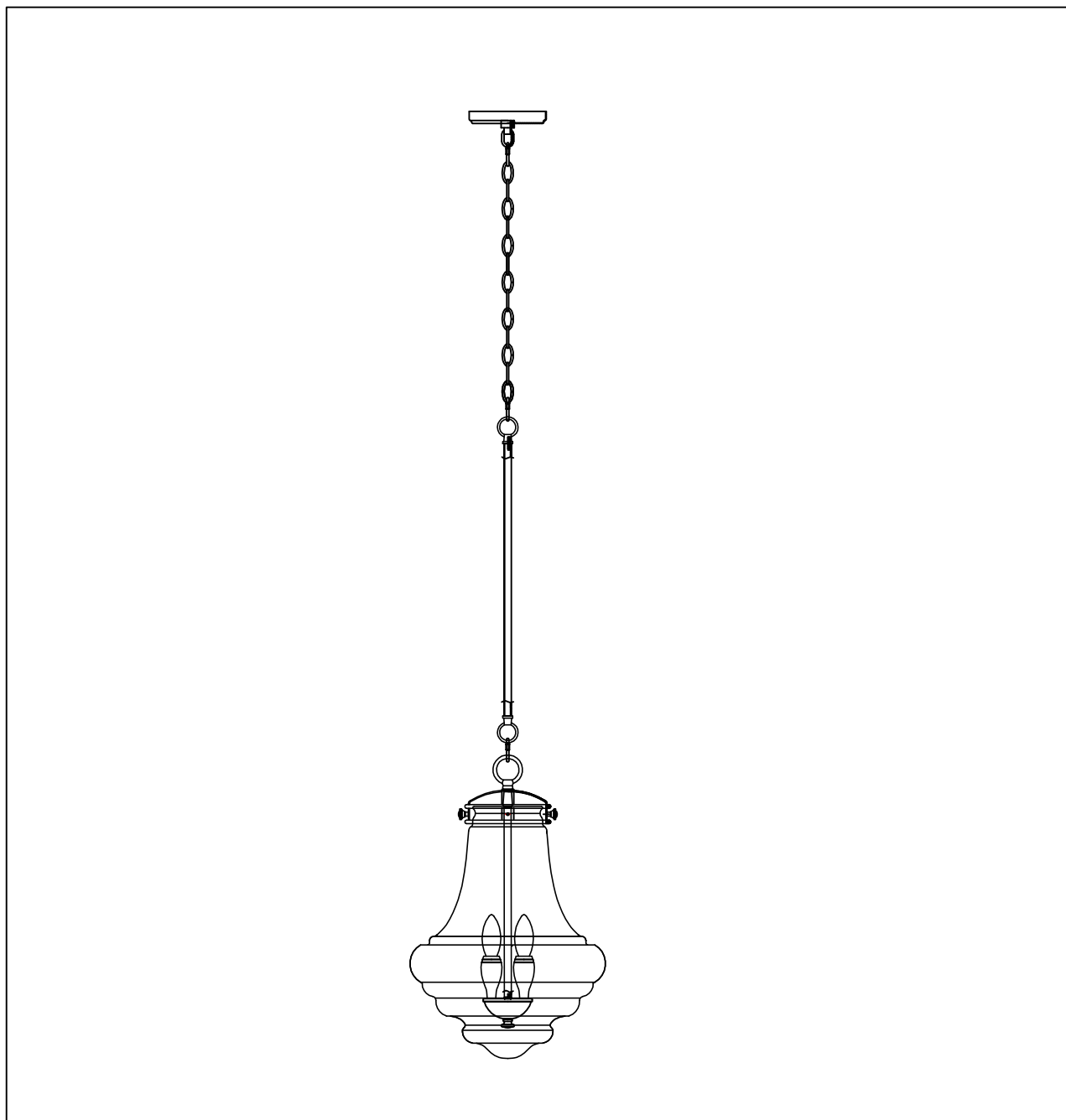

PRODUCT NAME: Retro

ITEM NUMBER: 25187

Please consult your electrician for hanging fixture and wiring.



Bulb(not included) :3*CA 60W

IMPORTANT: Turn off power at the main fuse or circuit breaker box before starting installation



(A) Bracket

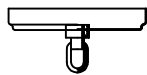

(B) Canopy

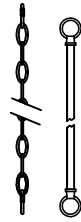

(C) Stem and Chain



(D) Body

Locate all hardware & components before discarding packaging

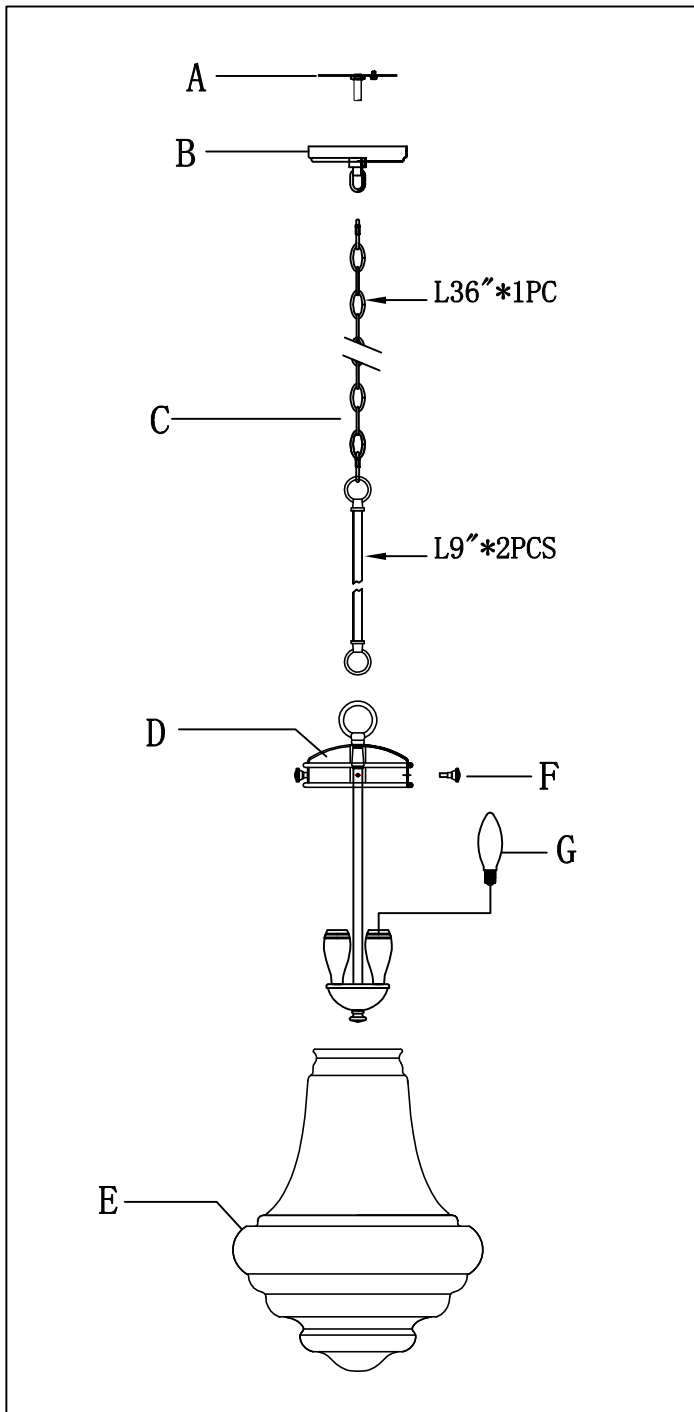

1.)

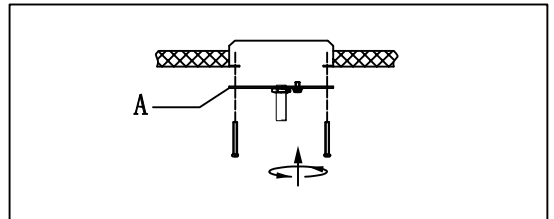

Step. 1: Remove mounting bracket(A) from fixture and install to electrical box.

2.)

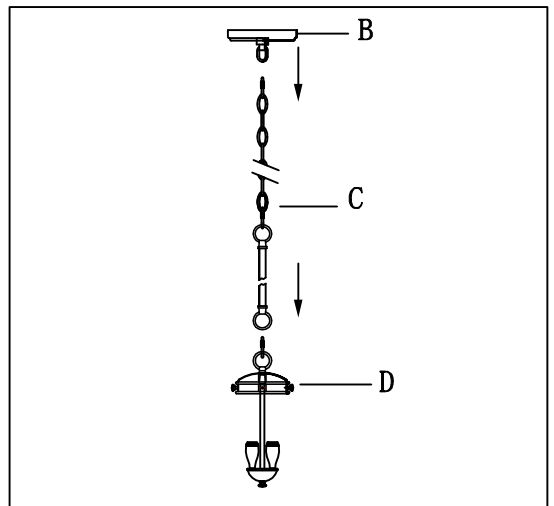

Step. 2: Run wire through stems and Chain (C) and combine Chain lengths to meet desired mounting height.

3.)

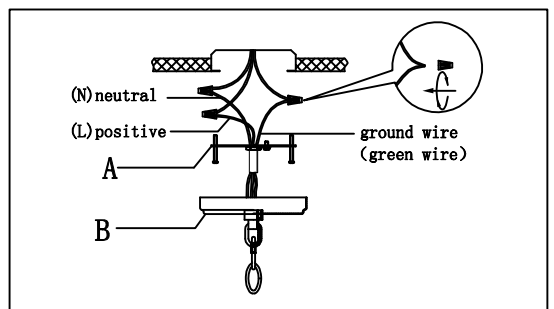

Step. 3: Wire fixture to wires in outlet box. Copper/Green wire is for Ground.

Cleaning & Care:

Clean with soft cloth and a mild detergent.
Do not use abrasive cleaner.

IMPORTANT: Turn off power at the main fuse or circuit breaker box before starting installation

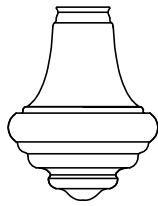

(E) Shade



(F) Lock nut



(G) Bulb

Locate all hardware & components before discarding packaging

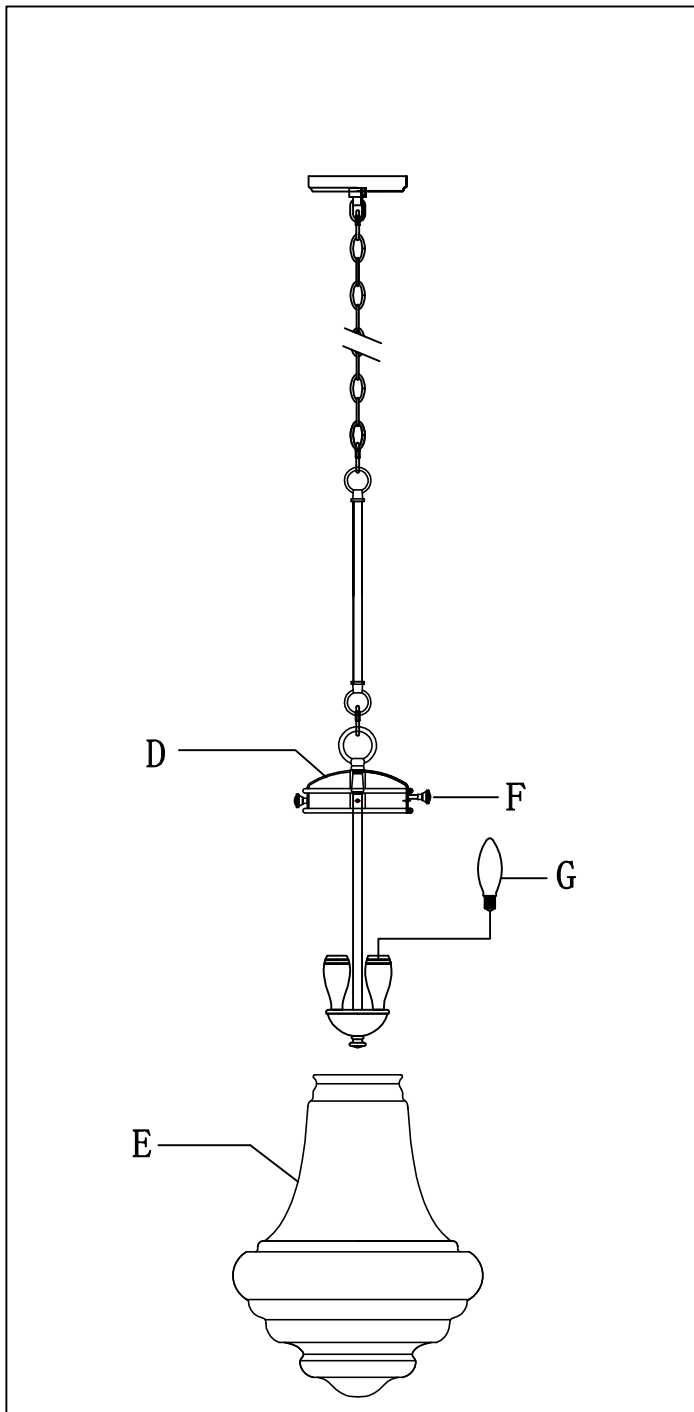

4.)

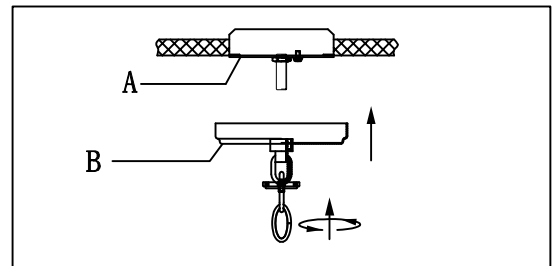

Step. 4: Install fixture to bracket and tighten screws at the ends of the canopy (B) to secure.

5.)

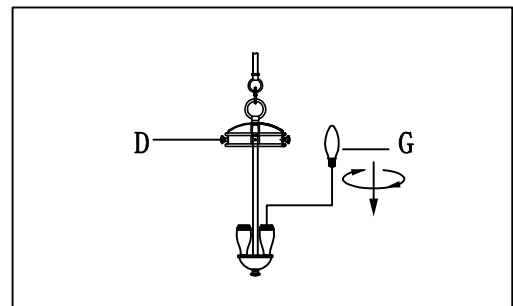

Step. 5: Install the bulb

6.)

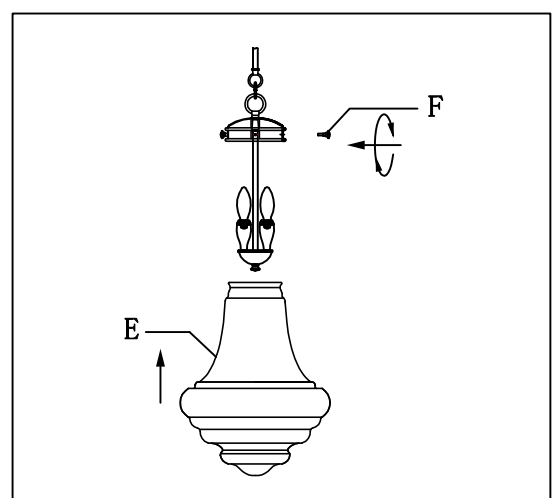

Step. 6: Use lock screws (F) to secure glass (E) to fixture.

Cleaning & Care:

Clean with soft cloth and a mild detergent.
Do not use abrasive cleaner.