

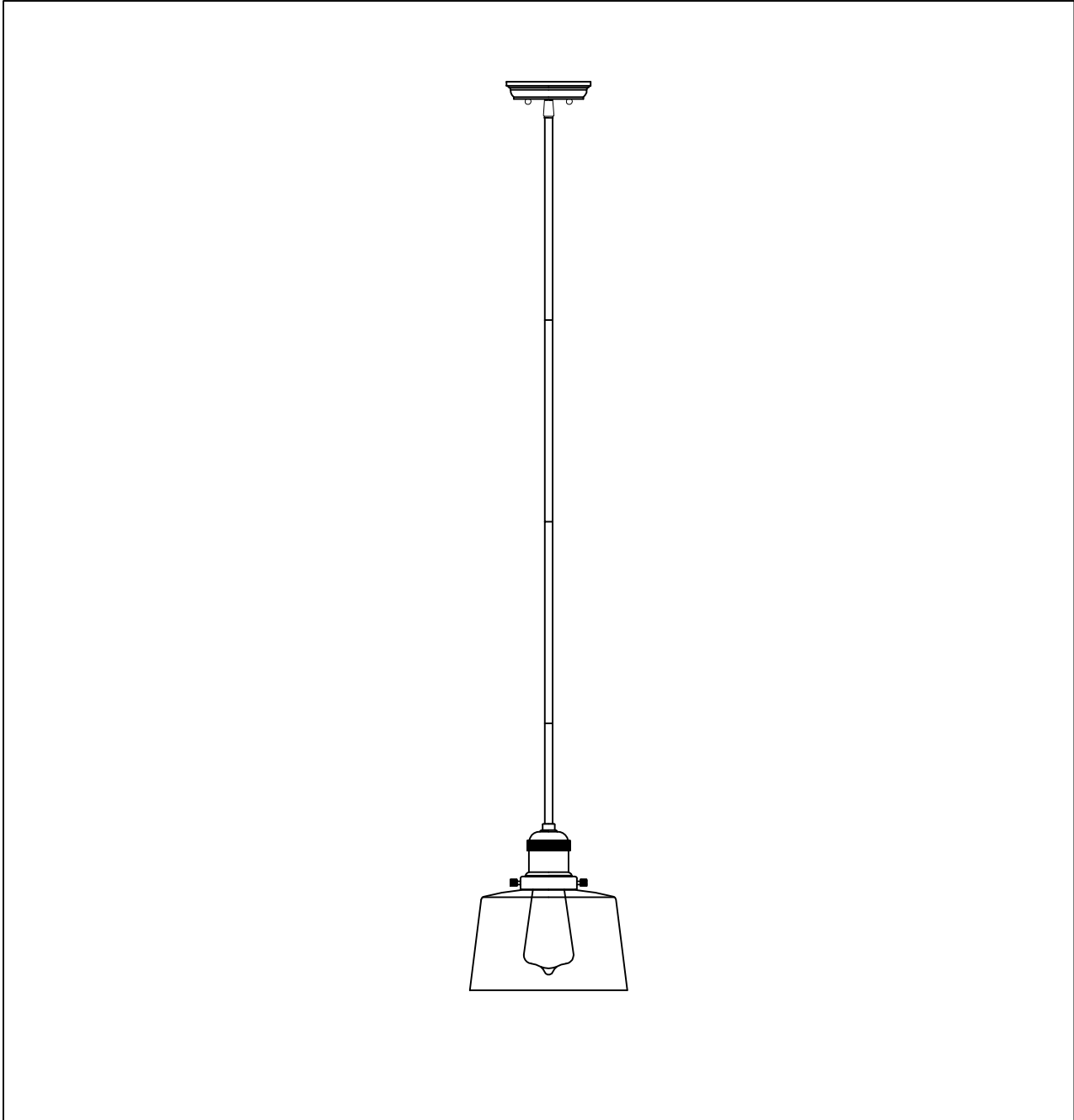

PRODUCT NAME: MI NI HI-BAY
ITEM NUMBER: 25049

Please consult your electrician for hanging fixture and wiring.



Bulb(not included):1 Edison-style bulbs recommended

IMPORTANT: Turn off power at the main fuse or circuit breaker box before starting installation

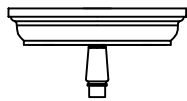

(A) Canopy

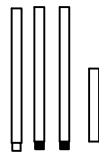

(B) Stems



(C) Body



(D) Socket ring

Locate all hardware & components before discarding packaging

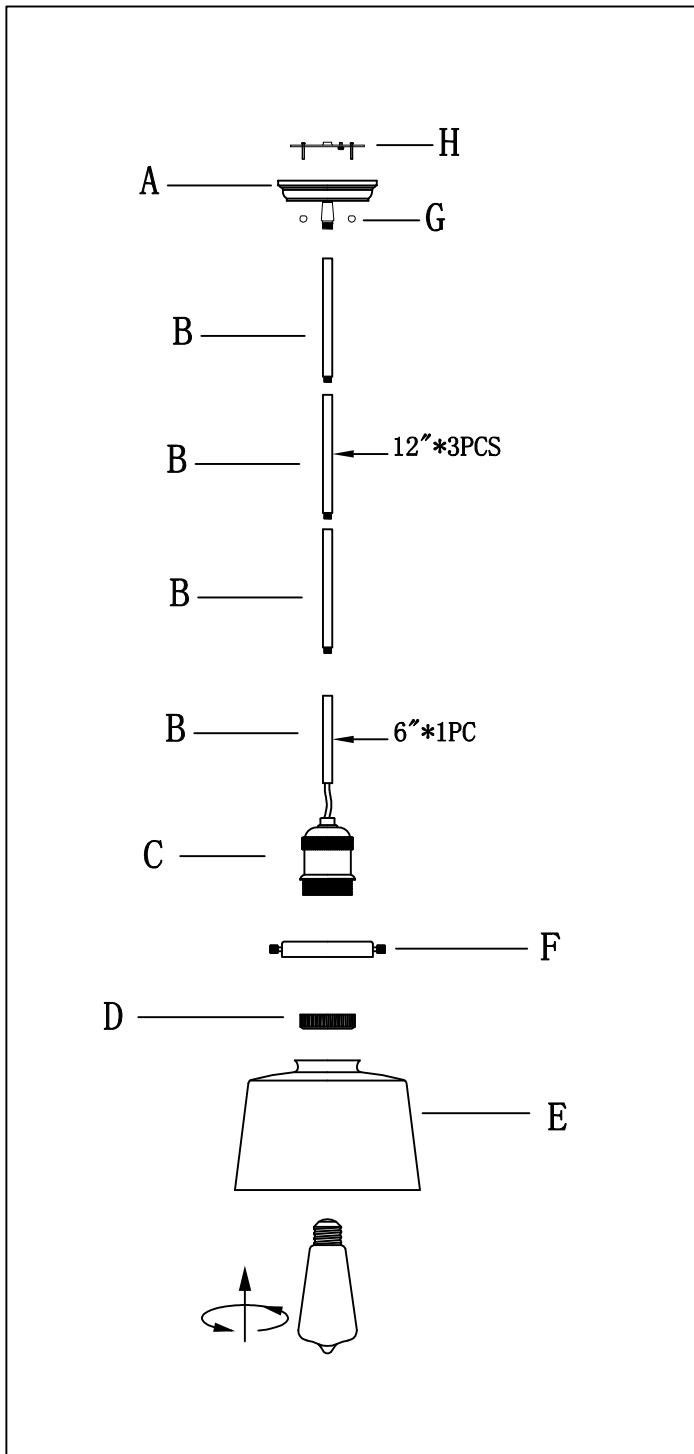

1.)

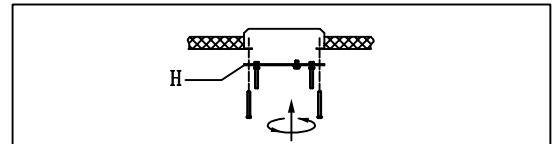

Step. 1: Remove mounting bracket(H) from fixture and install to electrical box.

2.)

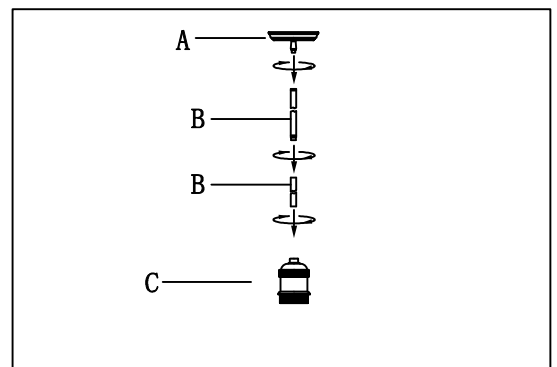

Step. 2: Run wire through stems(B) and combine stem lengths to meet desired mounting height.

3.)

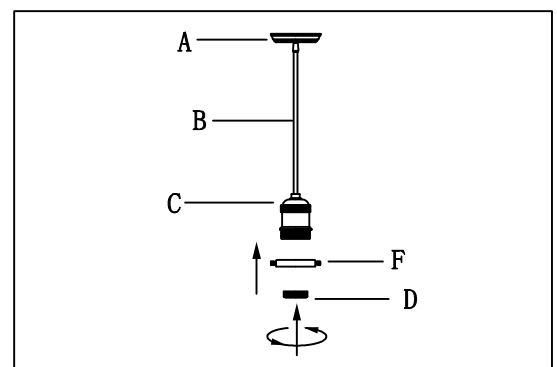

Step. 3: Use socket ring(D) to lock the plate(F) on socket.

Cleaning & Care:

Clean with soft cloth and a mild detergent. Do not use abrasive cleaner.

IMPORTANT: Turn off power at the main fuse or circuit breaker box before starting installation

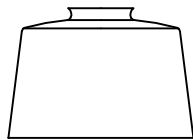

(E) Glass

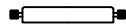

(F) Plate



(G) Ball nut

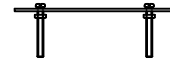

(H) Bracket

Locate all hardware & components before discarding packaging

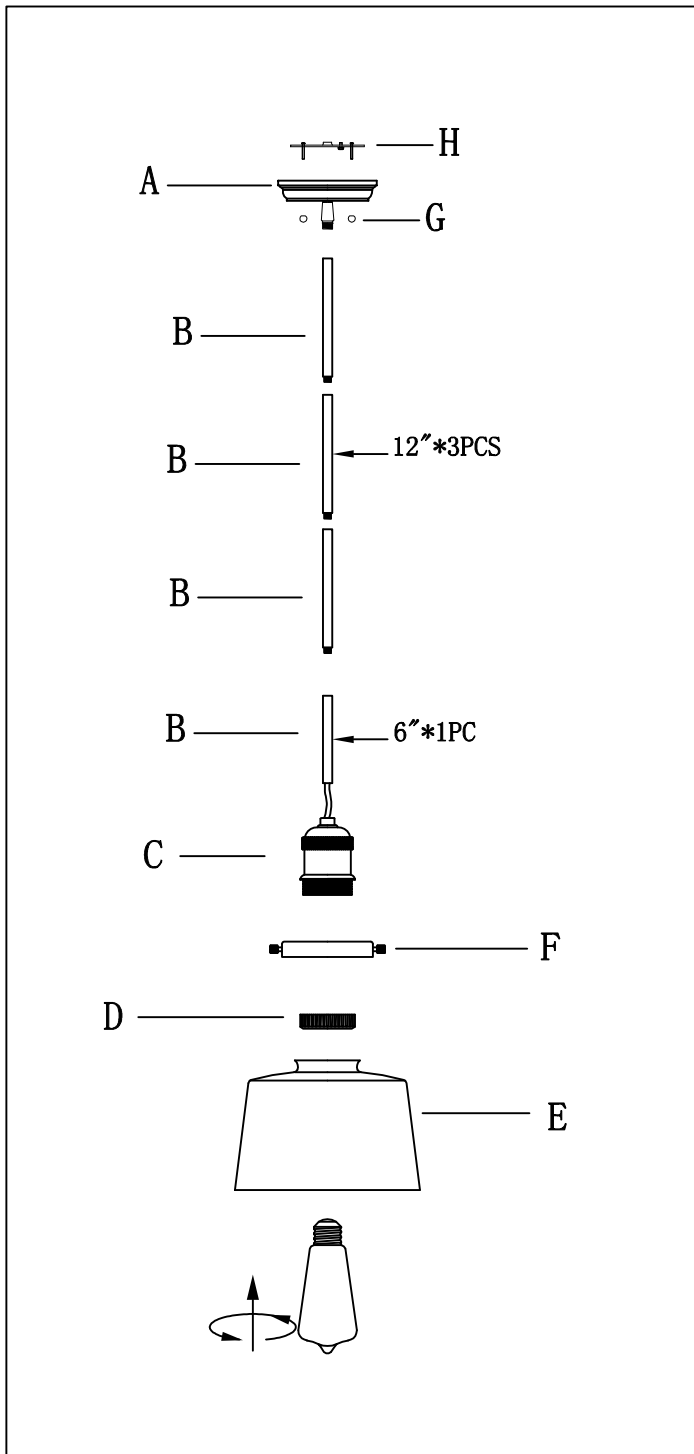

4.)

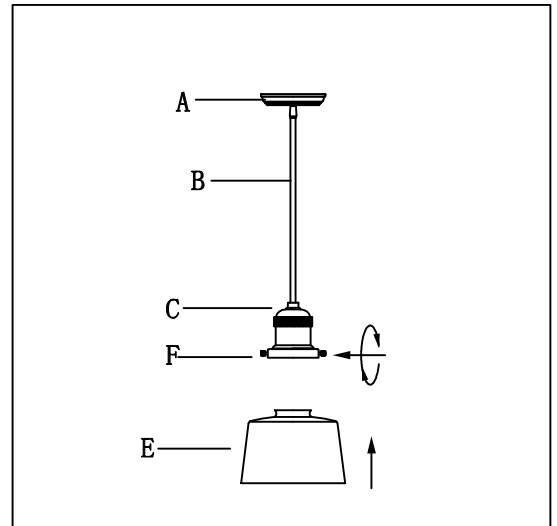

Step. 4: Install glass (E) into plate (F), and use the screw which on the side of Plate (F) and lock the glass under the Plate.

5.)

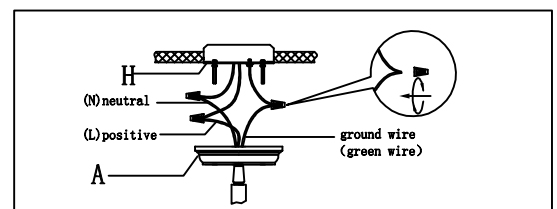

Step. 5: Wire fixture to wires in outlet box. Copper/Green wire is for Ground.

6.)

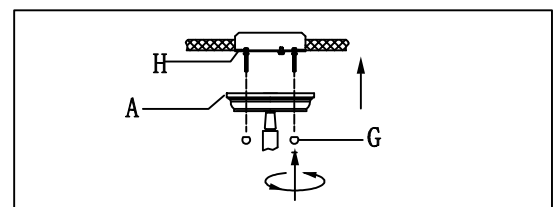

Step. 6: Install fixture to bracket and tighten ball nuts (G) on the canopy to secure.

Cleaning & Care:

Clean with soft cloth and a mild detergent. Do not use abrasive cleaner.