

PRODUCT NAME: Tubular 10 Light Pendant
ITEM NUMBER: 20827BZFAB

Please consult your electrician for hanging fixture and wiring.

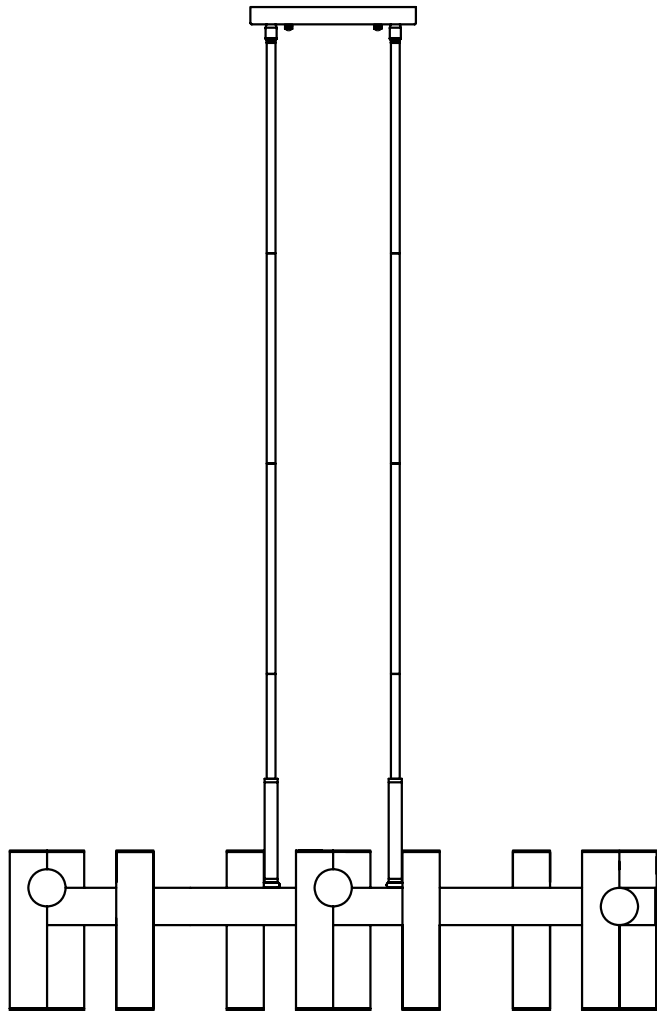

This fixture is designed to dim with an Electronic Low Voltage dimmer. Dimming levels will vary by dimmer. Below is a List of Recommended Dimmers:

- Lutron DVELV-330P
- Lutron MAELV-600M
- Lutron SAELV-153P
- Leviton IPL06-10Z
- Leviton 6674-POW
- Legrand Tru-Universal ADTP703TUW4

Due to inrush current wattage should not exceed 150 watts of product for a 600 watt dimmer.

Bulb(included) 10xLED 6W

IMPORTANT: Turn off the power at the main fuse or circuit breaker box before starting installation

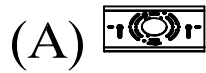

(A) Mounting Bracket

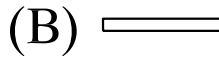

(B) Canopy

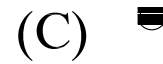

(C) Ball Nuts(2PCS)

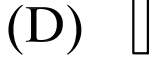

(D) Tubes(2PCS)

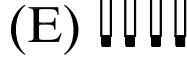

(E) Rods(1*6"+3*12")x2



(F) Swivels(2PCS)

Locate all hardware & components before discarding packaging

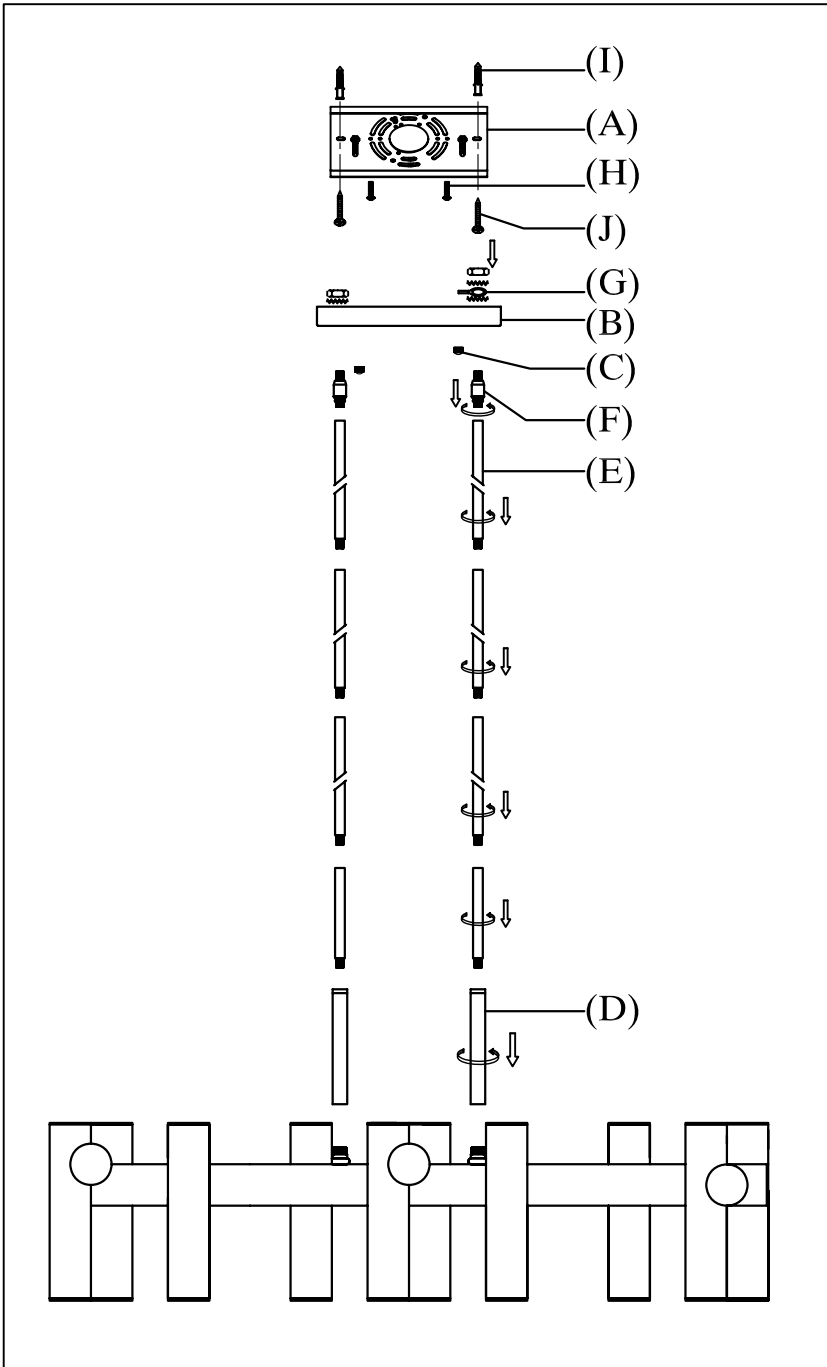

1.)

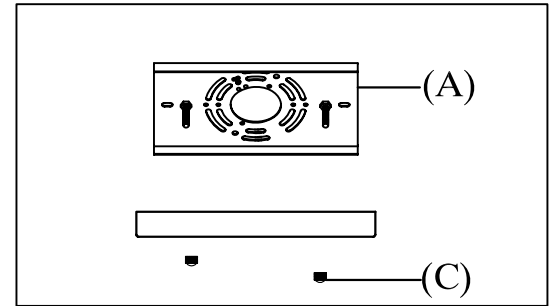

step1:Remove mounting bracket from canopy.

2.)

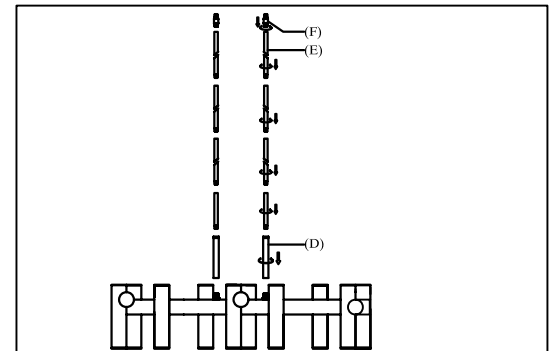



step2:Run wire through stems and combine stem lengths to meet desired mounting height.

Cleaning & Care:

Clean with soft cloth and a mild detergent.
Do not use abrasive cleaner.

IMPORTANT: Turn off the power at the main fuse or circuit breaker box before starting installation

(G) 
Ground Wire

(H) 
Canopy

(I) 
Anchor(2PCS)

(J) 
Dry Wall Screw(2PCS)

Locate all hardware & components before discarding packaging

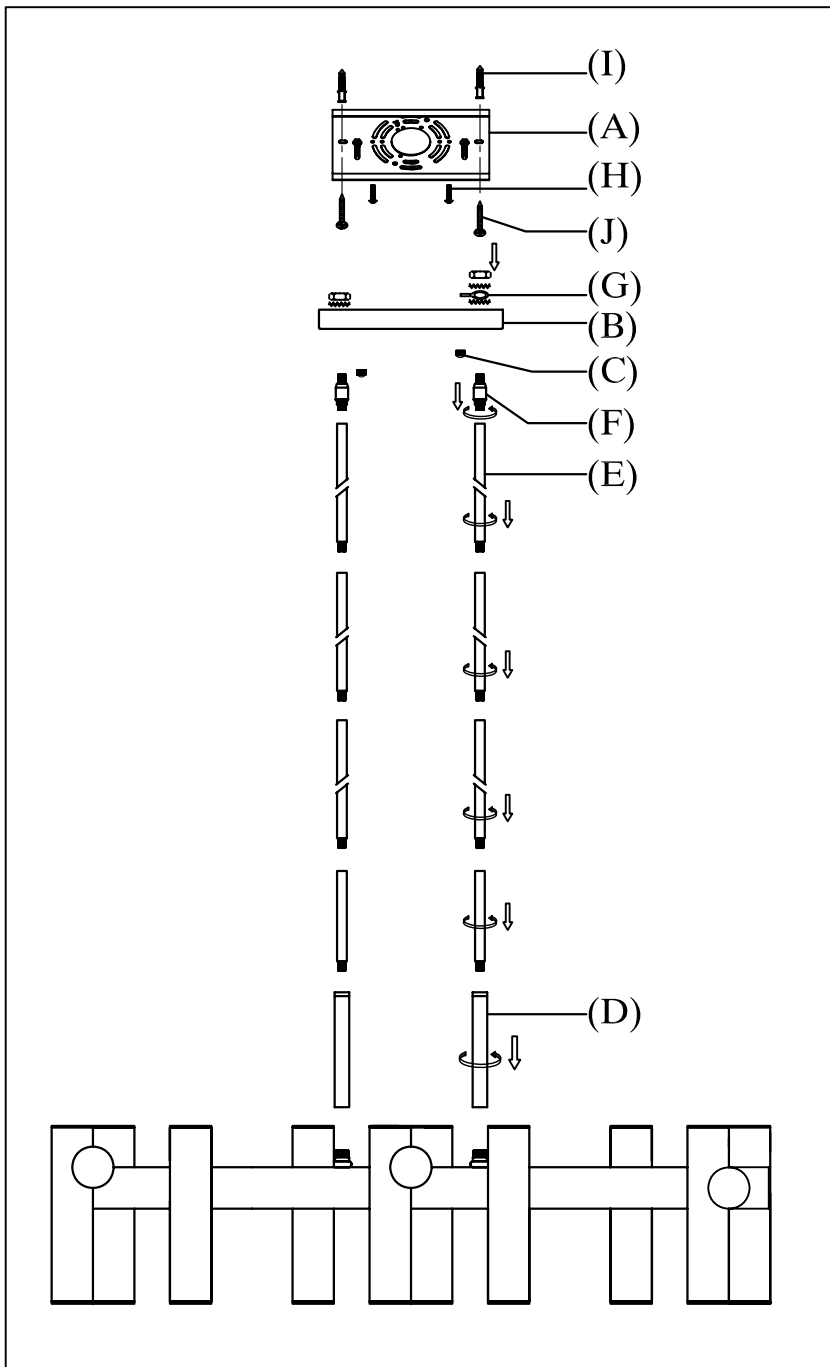

1.)

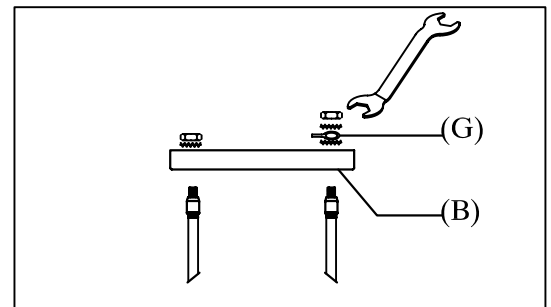

step3:Secure the rod assembly to the set nipple of the canopy as shown in diagram.

2.)

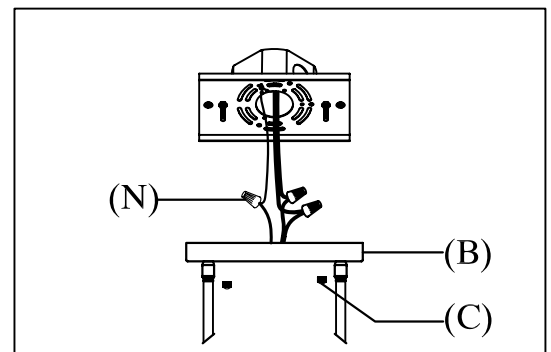

step4:Mark where screws at ends of bracket meet the ceiling. Remove mounting bracket from ceiling. Drill holes using $3/16'' \pm$ drill bit where marked. Install mounting bracket to outlet box and attach anchors to secure bracket at ends. Wire fixture to wires in outlet box. Green wire is for Ground. Install fixture to bracket and tighten ball nuts at the ends of the canopy to secure.

Cleaning & Care:

Clean with soft cloth and a mild detergent.
Do not use abrasive cleaner.